

CHALLENGER ANALOGUE PANEL METERS



Features

- Measurement and indication of AC amps, volts, frequency and DC signals
- Surface or window mounting
- Rear zero adjuster on moving coil meters
- High torque pivot and jewel movement
- True RMS measurement meters
- AC and DC inputs
- Up to 40A DC direct connected
- Up to 50A AC direct connected

Benefits

- AC moving iron and moving coil mechanisms
- Reduced inventory
- 4 ANSI standard case sizes
- Detachable lower fascia plate
- Easy to modify for distributors
- Through holes for back of panel mounting

Applications

- Marine panels
- Switchgear
- Distribution systems
- Control panels
- Embedded generation
- Energy management
- Building management
- Utility power monitoring
- Process control
- Motor monitoring

Compliant with

- ANSI C39.1 1981
- IEC 51
- UL3111-1
- EMC
- LVD
- UL and CUL file no: E236986

The Challenger range of analogue panel meters offers accurate measurement and indication of most electrical and electronic parameters in industry standard 1½", 2½", 3½" and 4½" case sizes. This innovative design features a detachable lower fascia plate, which allows the flexibility of either surface or window mounting. The fascia is simply unclipped to achieve the completely flush panel appearance of rear of panel window mounting.

The range offers AC and DC ammeters, voltmeters and frequency meters utilising a high torque pivot and jewel movement. AC moving coil rectified meters provide 1.5% accuracy of the full scale value and feature a rear zero adjuster screw for tamperproof installation. AC moving iron meters also provide 1.5% high accuracy and true RMS measurement.

Operation

The Challenger analogue panel meters utilise a traditional pivot and jewel movement, incorporating specially hardened steel pivots and a spring loaded jewel. This robust mechanism is ideally suited for all applications, including the most demanding conditions.

Moving Coil Meters

These meters offer a centre cored, self-shielding moving coil movement using pivots, hairsprings and sprung jewels. Variations in movement are limited by design. All DC voltmeters are 1000 ohms per Volt, moving coil rectified products run at 900 ohms per Volt. Millivolt meters use a 5 milliamps/50mV movement.

Moving Iron Meters

This clapper type repulsion design utilises a pivot, hairspring and jewel movement. The bottom jewel is oil filled to provide damping while the top is sprung for resilience. All voltmeters are manufactured with internal voltage dropper resistors.

Frequency Meters

Frequency meters utilise a 1mA/35 ohm DC moving coil movement driven by an EMC hard frequency conversion circuit.

Dials, Pointers and Scales

Standard dials are matt white with black printed scales and a tubular knife-edge black matt pointer. The 90° scales are balanced within 1% of scale length and feature a highly repeatable flattened arc scale shape, ensuring consistently accurate measurement readings. Dials are interchangeable between the Challenger meters for inputs within the published specifications of the meter. Options for non standard customised dials are available upon request.

Current Transformers and Shunts

Crompton Instruments, a Business Unit of TE Connectivity Ltd, offers a comprehensive range of current transformers and shunts, for driving the Challenger panel meters for the safe and simple measurement of AC and DC currents.

Our extensive range of current transformers provides accurate measurement of AC current and ratio matching to a consistent 5 or 1 amp secondary current, proportional to the primary current.

Our range of shunts ensures a DC millivolt signal exactly proportional to the system current for driving ammeters, providing accurate measurement of DC current up to 12000A, with secondary inputs of, 50, 60, 75 or 100mV DC to match the Challenger input.



Model 361 (1 1/2")



Model 362 (2 1/2")



Model 363 (3 1/2")



Model 364 (4 1/2")

Specifications

Accuracy	
DC ammeters and voltmeters:	1.5% 0-100% of full scale deflection
AC ammeters and voltmeters:	Moving iron: 1.5% 10-100% of full scale deflection Moving coil: 1.5% 10-100% of full scale deflection
Frequency meters:	0.5% of end scale value
Input ratings	
DC moving coil ammeters:	50µA - 40A DC. (Model 361: 10A max)
DC moving coil voltmeters:	50mV - 600V DC
DC moving coil centre zero ammeters:	+/-50mA to +/-40A DC. (Model 361: 10A max)
DC moving coil centre zero voltmeter:	+/-50mV to +/-600V DC. Standard 1k ohm/volt
DC moving coil suppressed zero ammeters:	4/20mA DC
DC moving coil suppressed zero voltmeters:	1/5, 8/16, 16/32 or 12/24V DC
AC moving coil ammeters:	100µA - 750mA AC
AC moving coil voltmeters:	20 - 600V AC. Standard 900 ohms/volt
AC moving iron ammeters:	1 - 50A AC (Model 361: non applicable)
AC moving iron voltmeters:	3 - 600V AC (Model 361: non applicable)
Frequency:	100/130V, 200/250V, 360/440V, 50Hz, 60Hz or 400Hz (Model 361: non applicable)
Burden:	Ammeter: 0.5VA Voltmeter: 4.5VA
Frequency:	4VA
Overload:	1.2 continuous x 10 for 0.5 seconds
Enclosure	
Movement:	High torque pivot and jewel moving coil and moving iron
Scale balance:	Within 1% of scale length
Relative humidity:	25% - 80% nominal range of use
Operating temperature:	0°C to +40°C (-32°F to +104°F)
Storage temperature:	-20°C +55°C (-4°F to +131°F)
Case and lower mask:	Black matt case UL94V. Polycarbonate cover
Window:	Shatterproof polycarbonate
Surface mounting:	4 corner studs
Rear of panel mounting:	2 through hole mounts (Model 361: facility pending)
Compliant with	
UL and CUL:	61010B-1 File no: E236986
Performance:	ANSI C39.1 1981 and IEC 51
Scaling:	ANSI C39.1 1981
Safety:	IEC61010-1 (LVD) and BS EN61326:1998 (EMC)
Vibration:	ANSI C39.1 1981 cl. 5.13

Product Codes

Input	Model 361 cat. no.	Model 362 cat. no.	Model 363 cat. no.	Model 364 cat. no.
DC moving coil amps	361-01A	362-01A	363-01A	364-01A
DC moving coil volts	361-01V	362-01V	363-01V	364-01V
DC moving coil centre zero amps	361-01C	362-01C	363-01C	364-01C
DC moving coil centre zero volts	361-01N	362-01N	363-01N	364-01N
DC moving coil suppressed zero amps	361-01R	362-01R	363-01R	364-01R
DC moving coil suppressed zero volts	361-01S	362-01S	363-01S	364-01S
AC moving coil amps	361-01B	362-01B	363-01B	364-01B
AC moving coil volts	361-01W	362-01W	363-01W	364-01W
AC moving iron amps	N/A	362-02A	363-02A	364-02A
AC moving iron volts	N/A	362-02V	363-02V	364-02V
Frequency	N/A	362-41S	363-41S	364-41S

Please specify current, voltage, frequency and required options at time of ordering.



Connections

DC Amps - Self contained

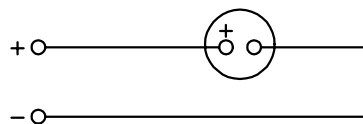

DC Amps - For use with external shunt

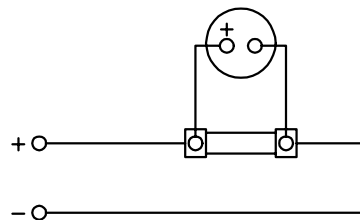

DC Volts

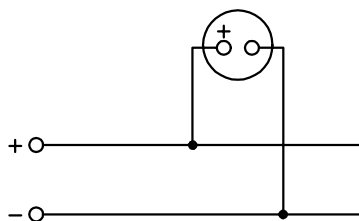

AC Amps - Self contained

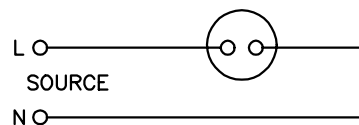

AC Amps - For use with current transformer

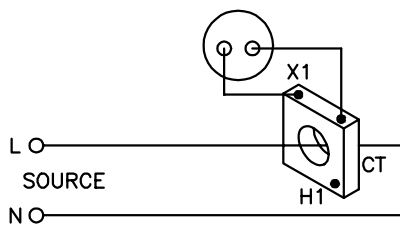

AC Volts

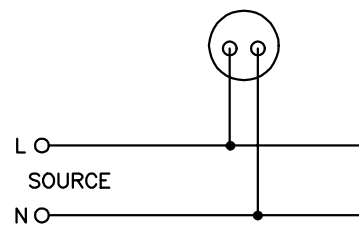

Frequency Meter

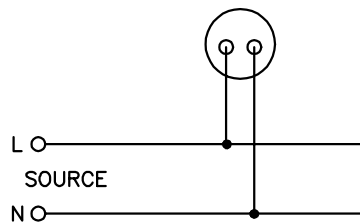

Dimensions - Surface Mount

Model 361

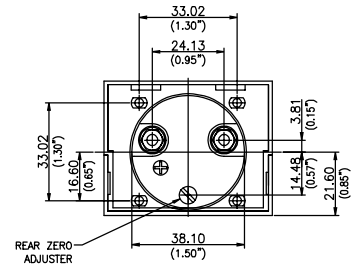
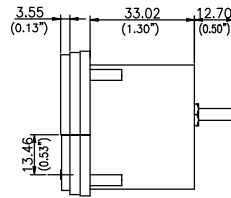
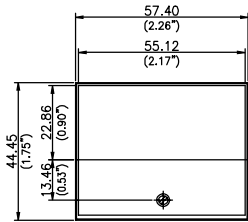

Model 362

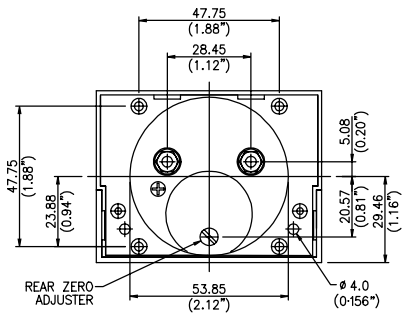
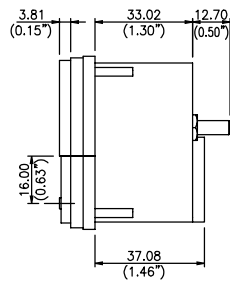
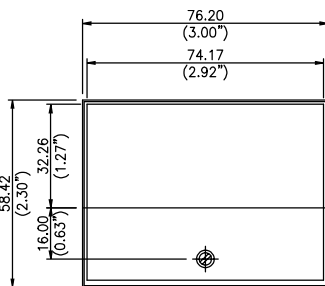

Model 363

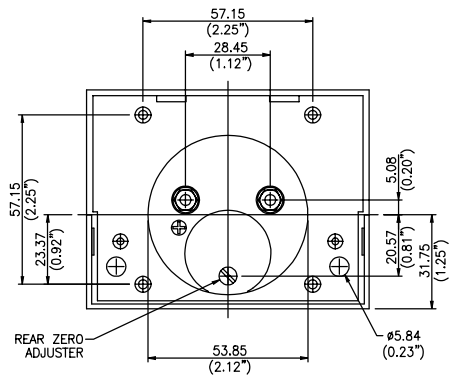
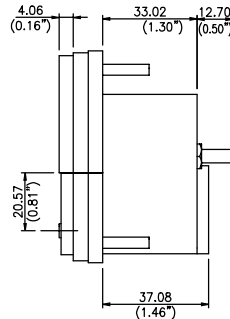
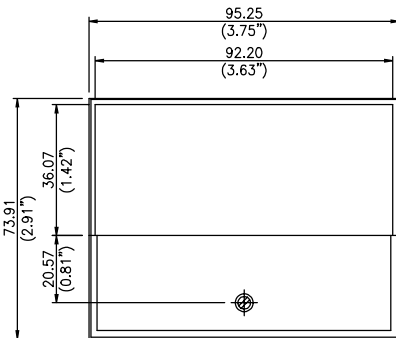

Model 364

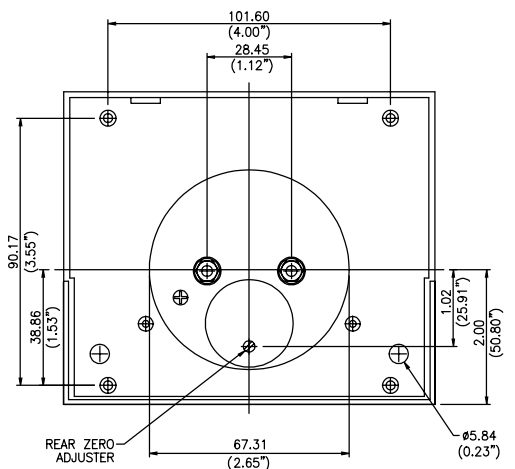
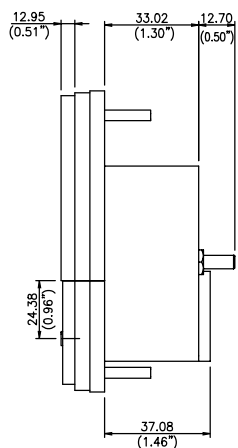
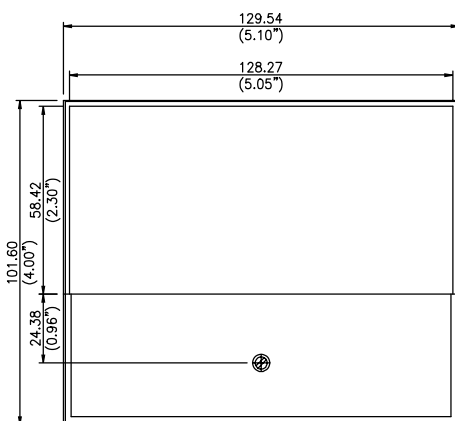

Model 361
Surface Mount Cut-out

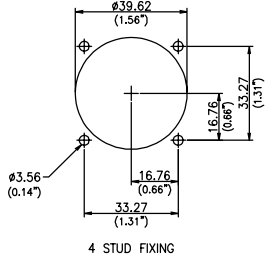

4 STUD FIXING

Window Mount Cut-out

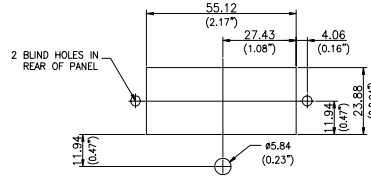

PANEL CUT-OUT FOR WINDOW MOUNTING

Model 362
Surface Mount Cut-out

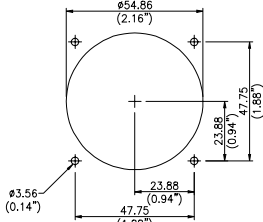

4 STUD FIXING

Window Mount Cut-out

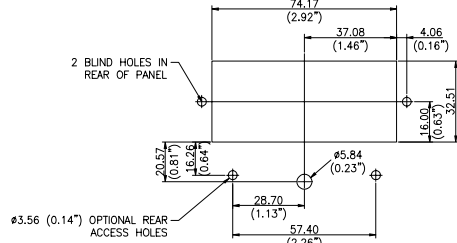

PANEL CUT-OUT FOR WINDOW MOUNTING

Model 363
Surface Mount Cut-out

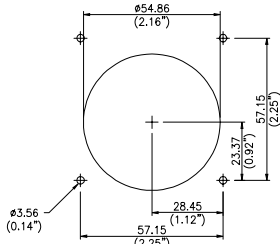

4 STUD FIXING

Window Mount Cut-out

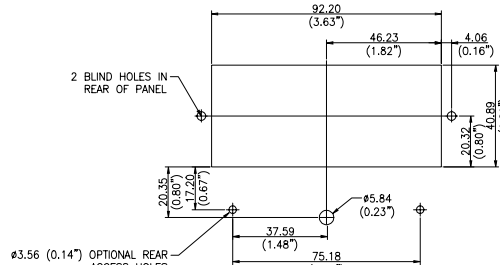

PANEL CUT-OUT FOR WINDOW MOUNTING

Model 364
Surface Mount Cut-out

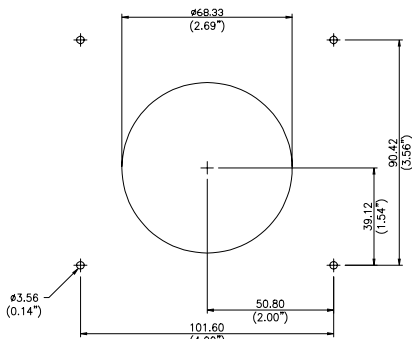

4 STUD FIXING

Window Mount Cut-out

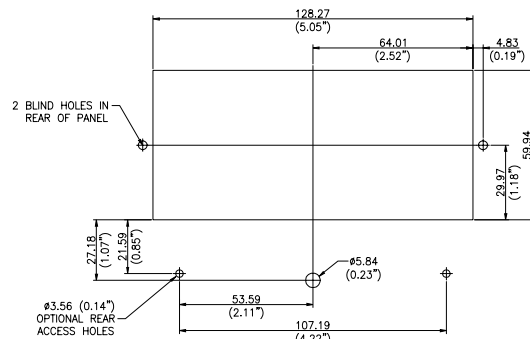

PANEL CUT-OUT FOR WINDOW MOUNTING